

CPS nano plus 3 Phase WYE 120 V

Power Line SPDs
NEMA - TVSS



General Data

Surge modules	7
Network configuration	3 Phase WYE
IEC SPD Type	Class II
UL SPD Type	Type 2
Format	Hardwired
Protection Modes	Common & differential protection
Product standards	IEC 61643-11; UL 1449 4th edition

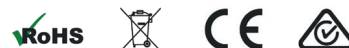

PART NUMBERS

XXX	40	60	80	120	160
CPS nano plus XXXKA 3PhWYE 120V	77797714	77797724	77797734	77797744	77797754

SURGE PROTECTION DEVICE (SPD) - IEC TECHNICAL FEATURES

CPS nano plus XXXKA 3PhWYE 120V	40	60	80	120	160
Nominal voltage AC 50-60 Hz - Un [V]	120/208				
Nominal voltage AC 50-60 Hz - Un(L-L) [V]	208				
Nominal voltage AC 50-60 Hz - Un(L-N) [V]	120				
Max Discharge Current (8/20) - I _{max}	40kA/ph	60kA/ph	80kA/ph	120kA/ph	160kA/ph
Maximum back-up fuse [A [gG]]	63				
Response time - t _A [ns]	≤1				
Dynamic thermal disconnection	Yes				

SURGE PROTECTION DEVICE (SPD) - UL TECHNICAL FEATURES

CPS nano plus XXXKA 3PhWYE 120V	40	60	80	120	160
Nominal discharge current (8/20) - I _n [kA]	10			20	
Maximum continuous operating voltage - MCOV (L-N) [V]	175				
Voltage protection rating - VPR (L-L) [V]	1200				
Voltage protection rating - VPR (L-N) [V]	600				
Voltage protection rating - VPR (L-G) [V]	600				
Voltage protection rating - VPR (N-G) [V]	600				
Short-Circuit Current Rating-SCCR [kA]	100				
Multi-discharge system - MDS	Yes				

TECHNICAL FEATURES

CPS nano plus XXXKA 3PhWYE 120V	40	60	80	120	160
Intelligent aging display led - IAD	100, 50, 0 %				
EMI Filter	Yes				
EMI Filter Common Mode	≤40 dB				
EMI Filter Differential Mode	≤40 dB				

DATASHEET

This document is subject to change at any time without notice www.cirprotec.com | Lepanto 49 · 08223 Terrassa, Barcelona Spain © 2024 Cirprotec SLU | All rights reserved

cirprotec

CPS nano plus 3 Phase WYE 120 V

MECHANICAL AND ENVIRONMENTAL FEATURES

CPS nano plus XXXKA 3PhWYE 120V	40	60	80	120	160
Temperature range [°C]	-40 ... 70				
Indication System Type	Voltage LED, Protection status LED				
Insulating material	Polycarbonate				
Enclosure - IP	IP66				
Enclosure NEMA Type	4				
Flammability class	UL94 V-0				
Stranded conductor cross section	2,5 mm ²				
Stranded conductor AWG dimensions	#14				

DIMENSIONS AND WEIGHT

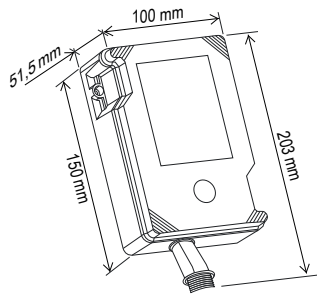

CPS nano plus XXXKA 3PhWYE 120V	40	60	80	120	160
Net Weight [kg]	1.032				
Gross weight [kg]	1.106				
Packaging dimensions (H x W x L) [mm]	255 × 106 × 61				

INTERNAL CONFIGURATION

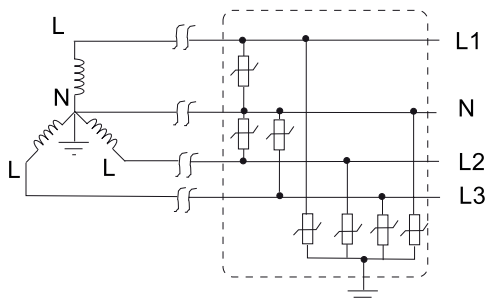

DATASHEET